

DOCUMENTACIÓN TÉCNICA



Ref.: CLP17-I-L

Columpio Vivaldi

UNE EN 1176-1:2018

UNE EN 1176-2:2018



Altura libre de caída: 1,32 m

Edad recomendada de uso: con asiento cuna de 0 a 3 años

Con asiento plano, nido e inclusivo a partir de 3 años

Componentes plásticos: Polietileno de alta densidad con protección UV

Larguero metálico galvanizado

Cadenas de columpio inoxidable

Tornillería protegida con tapones de polipropileno

Madera de pino tratada en autoclave Nivel IV

Asiento plano, cuna, nido e inclusivo

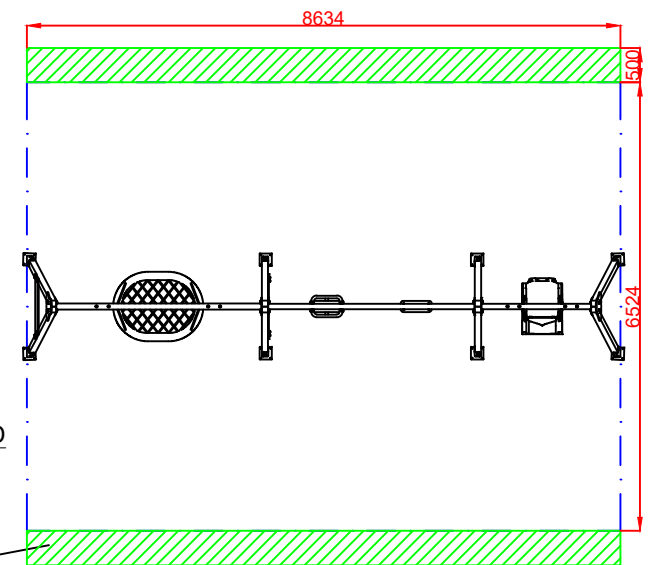
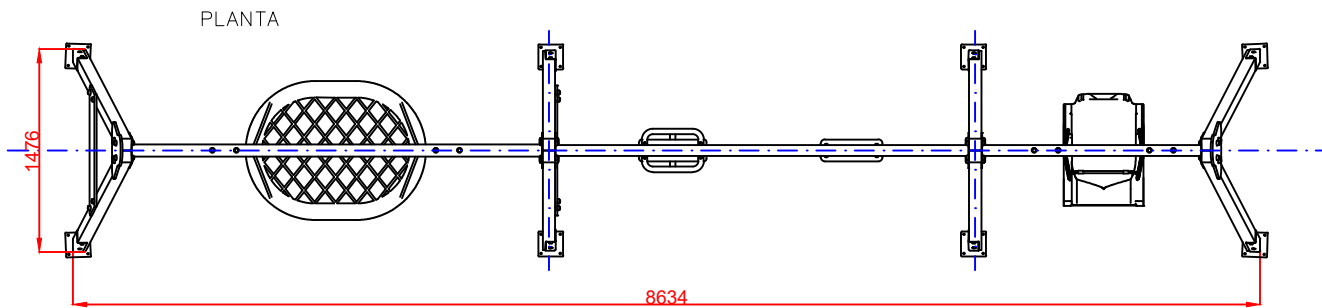
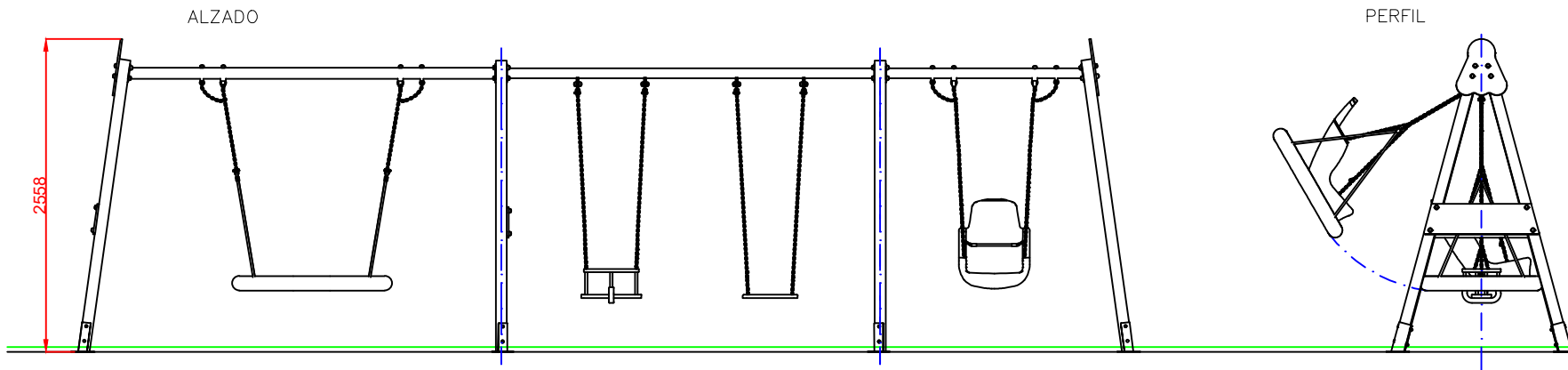

AREA DE SEGURIDAD

Superficie= 56,33 m²

E: 1/2

ZONA LIBRE DE OBSTÁCULOS

Dibujado		PLANO 1 VISTAS GENERALES		Ref: CLP17-I-L	
Revisado					
Aprobado		Descripción:	Escala:		Nº Hoja
		COLUMPIO VIVALDI			2/3
			Fecha:	21/01/2022	

PLANTA CIMENTACIÓN

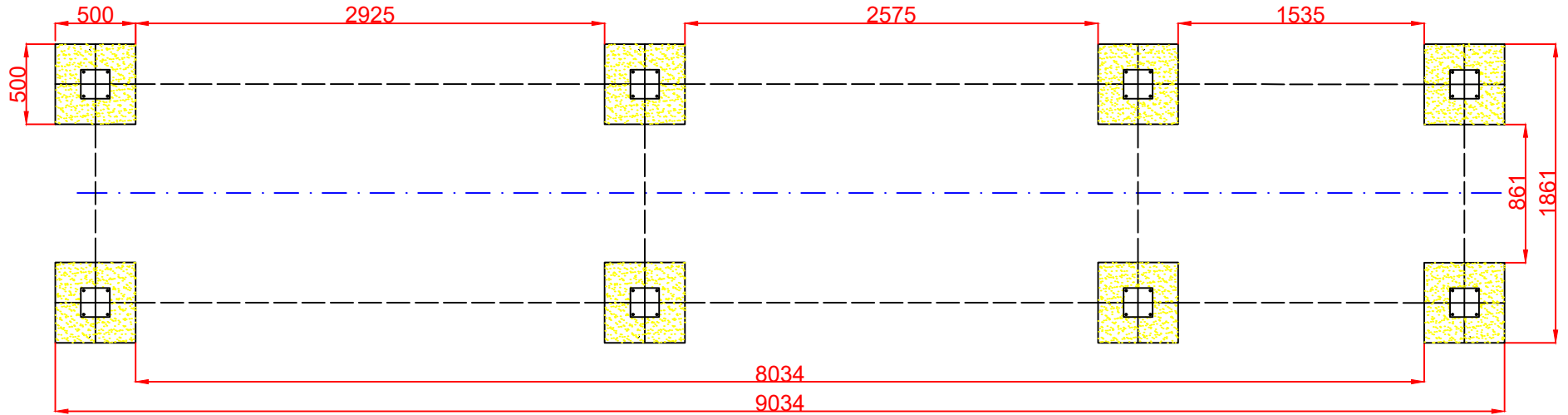

DETALLES CIMENTACIÓN

ESQUEMA DE CIMENTACIÓN EN ARENA

E: 2/1

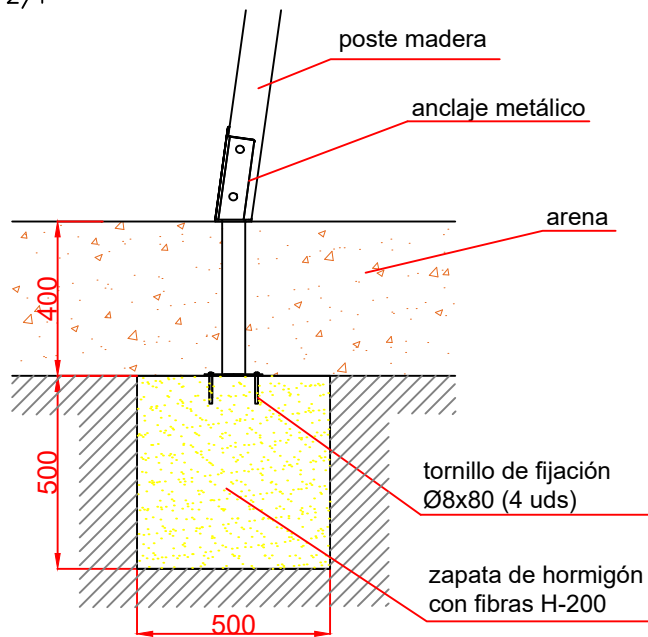

ESQUEMA DE CIMENTACIÓN EN HORMIGÓN

E: 2/1

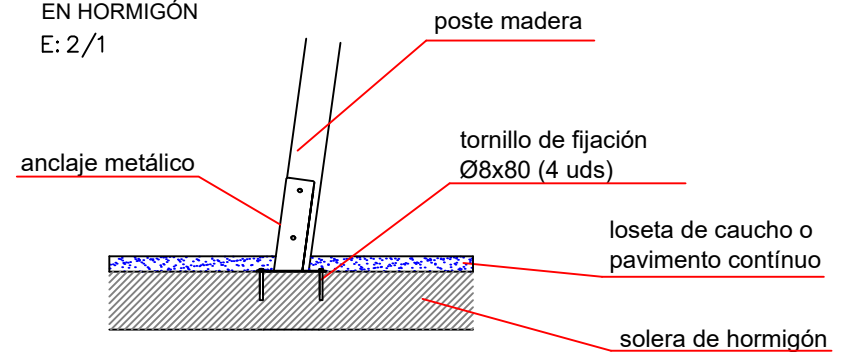

Dibujado		PLANO 2 CIMENTACIÓN	Ref:	CLP17-I-L
Revisado				
Aprobado				
Descripción:		COLUMPIO VIVALDI	Escala:	Nº Hoja 3/3
			Fecha:	21/01/2022

VARIANTES COLUMPIO VIVALDI

COLUMPIO VIVALDI ASIENTOS CUNA



Ref.: CLP17-I-L

COLUMPIO VIVALDI ASIENTOS PLANOS



Ref.: CLP17-I-L